

Surface Mount Transient Voltage Suppressor Diodes

Uni-directional

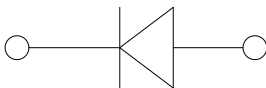
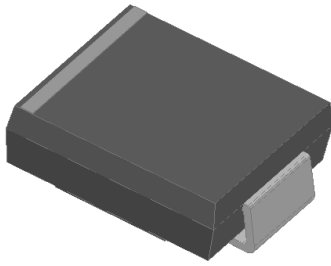

Features

- Low-profile package
- Ideal for automated placement
- Available in Uni-directional and Bi-directional
- 1500W peak pulse power capability with a 10/1000 μ s waveform
- Excellent clamping capability
- Low incremental surge resistance
- Very fast response time
- Meets MSL level 1, per J-STD-020, LF maximum peak of 260 °C
- ESD protection of data lines in accordance with IEC 61000-4-2, 30kV(Air), 30kV (Contact)
- Part no. with suffix "Q" means AEC-Q101 qualified

Bi-directional

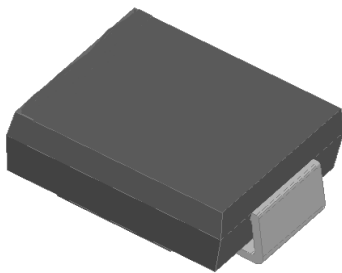

Typical Applications

For use in sensitive electronics protection against voltage transients induced by inductive load switching and lighting on ICs, MOSFET, signal lines of sensor units for consumer, automotive and telecommunication.

Mechanical Data

- **Package:** DO-214AB (SMC)
Molding compound meets UL 94 V-0 flammability rating, RoHS-compliant
- **Terminals:** Tin plated leads, solderable per J-STD-002 and JESD22-B102
- **Polarity:** For uni-directional types the band denotes cathode end, no marking on bi-directional types

■Maximum Ratings (T_a=25°C Unless otherwise specified)

PARAMETER	SYMBOL	UNIT	Conditions	Max
Peak power dissipation ⁽¹⁾⁽²⁾	P _{PPM}	W	with a 10/1000us waveform	1500
Peak pulse current ⁽¹⁾	I _{PPM}	A	with a 10/1000us waveform	See Next Table
Power dissipation ⁽²⁾	P _D	W	on infinite heat sink at T _L =75°C	6.5
Peak forward surge current ⁽³⁾	I _{FSM}	A	8.3 ms single half sine-wave unidirectional only	200
Operating junction and storage temperature range	T _J , T _{STG}	°C		-55 to +150



1.5SMC12AQ THRU 1.5SMC220CAQ

■Electrical Characteristics (T_a=25°C Unless otherwise specified)

PARAMETER	SYMBOL	UNIT	VALUE
Maximum instantaneous forward voltage at 100A for unidirectional only ⁽⁴⁾	V _{FM}	V	3.5

■Thermal Characteristics (T_a=25°C Unless otherwise specified)

PARAMETER	SYMBOL	UNIT	Conditions	VALUE
Thermal Resistance(Typical)	R _{θJA} ⁽⁵⁾	°C/W	junction to ambient	75
	R _{θJL}	°C/W	junction to lead	15

Notes:

- (1) Non-repetitive current pulse, per Fig. 3 and derated above T_A = 25°C per Fig.2.
- (2) Mounted on 0.31 x 0.31" (8.0 x 8.0 mm) copper pads to each terminal
- (3) Measured on 8.3ms single half sine-wave or equivalent square wave, duty cycle=4 pulses per minute maximum.
- (4) V_F=3.5V Max for devices of V_{BR}≤48V.
- (5) Mounted on minimum recommended pad layout.

■Electrical Characteristics (T_A=25°C unless otherwise noted)

Part Number (Uni)	Part Number (Bi)	Breakdown Voltage V _{BR} @I _T			Maximum Reverse Leakage I _R ⁽³⁾ @ V _{RWM} (μA)	Working Peak Reverse Voltage V _{RWM} (V)	Maximum Reverse Surge Current I _{PP} ⁽²⁾ (A)	Maximum Clamping Voltage V _c @ I _{PP} (V)
		Min(V)	Max (V)	I _T ⁽¹⁾ (mA)				
1.5SMC12AQ	1.5SMC12CAQ	11.40	12.60	1	5	10.2	89.8	16.7
1.5SMC13AQ	1.5SMC13CAQ	12.35	13.65	1	5	11.1	82.4	18.2
1.5SMC15AQ	1.5SMC15CAQ	14.25	15.75	1	1	12.8	70.8	21.2
1.5SMC16AQ	1.5SMC16CAQ	15.20	16.80	1	1	13.6	66.7	22.5
1.5SMC18AQ	1.5SMC18CAQ	17.10	18.90	1	1	15.3	59.5	25.2
1.5SMC20AQ	1.5SMC20CAQ	19.00	21.00	1	1	17.1	54.2	27.7
1.5SMC22AQ	1.5SMC22CAQ	20.90	23.10	1	1	18.8	49.0	30.6
1.5SMC24AQ	1.5SMC24CAQ	22.80	25.20	1	1	20.5	45.2	33.2
1.5SMC27AQ	1.5SMC27CAQ	25.65	28.35	1	1	23.1	40.0	37.5
1.5SMC30AQ	1.5SMC30CAQ	28.50	31.50	1	1	25.6	36.2	41.4
1.5SMC33AQ	1.5SMC33CAQ	31.35	34.65	1	1	28.2	32.8	45.7
1.5SMC36AQ	1.5SMC36CAQ	34.20	37.80	1	1	30.8	30.1	50.0
1.5SMC39AQ	1.5SMC39CAQ	37.05	40.95	1	1	33.3	27.8	53.9
1.5SMC43AQ	1.5SMC43CAQ	40.85	45.15	1	1	36.8	25.3	59.3
1.5SMC47AQ	1.5SMC47CAQ	44.65	49.35	1	1	40.2	23.2	64.8
1.5SMC51AQ	1.5SMC51CAQ	48.45	53.55	1	1	43.6	21.4	70.1
1.5SMC56AQ	1.5SMC56CAQ	53.20	58.80	1	1	47.8	19.5	77.0
1.5SMC62AQ	1.5SMC62CAQ	58.90	65.10	1	1	53.0	17.7	85.0
1.5SMC68AQ	1.5SMC68CAQ	64.60	71.40	1	1	58.1	16.3	92.0
1.5SMC75AQ	1.5SMC75CAQ	71.25	78.75	1	1	64.1	14.6	103
1.5SMC82AQ	1.5SMC82CAQ	77.90	86.10	1	1	70.1	13.3	113
1.5SMC91AQ	1.5SMC91CAQ	86.45	95.35	1	1	77.8	12.0	125
1.5SMC100AQ	1.5SMC100CAQ	95.00	105.00	1	1	85.5	11.0	137
1.5SMC110AQ	1.5SMC110CAQ	104.50	115.50	1	1	94	9.9	152
1.5SMC120AQ	1.5SMC120CAQ	114.00	126.00	1	1	102	9.1	165
1.5SMC130AQ	1.5SMC130CAQ	123.50	136.50	1	1	111	8.4	179
1.5SMC150AQ	1.5SMC150CAQ	142.50	157.50	1	1	128	7.3	207
1.5SMC160AQ	1.5SMC160CAQ	152.00	168.00	1	5	136	6.9	219
1.5SMC170AQ	1.5SMC170CAQ	161.50	178.50	1	5	145	6.4	234
1.5SMC180AQ	1.5SMC180CAQ	171.00	189.00	1	5	154	6.1	246
1.5SMC200AQ	1.5SMC200CAQ	190.00	210.00	1	5	171	5.5	274
1.5SMC220AQ	1.5SMC220CAQ	209.00	231.00	1	5	185	4.6	328

Notes:

- (1) Pulse Test: t_p≤50ms .
- (2) Surge current waveform per Fig. 3 and derated per Fig.2.



1.5SMC12AQ THRU 1.5SMC220CAQ

Ordering Information (Example)

PREFERRED P/N	PACKAGE CODE	UNIT WEIGHT(g)	MINIMUM PACKAGE(pcs)	INNER BOX QUANTITY(pcs)	OUTER CARTON QUANTITY(pcs)	DELIVERY MODE
1.5SMC SERIES	F1	Approximate 0.251	3000	6000	42000	13" reel

Characteristics (Typical)

FIG1: Peak Pulse Power Rating Curve

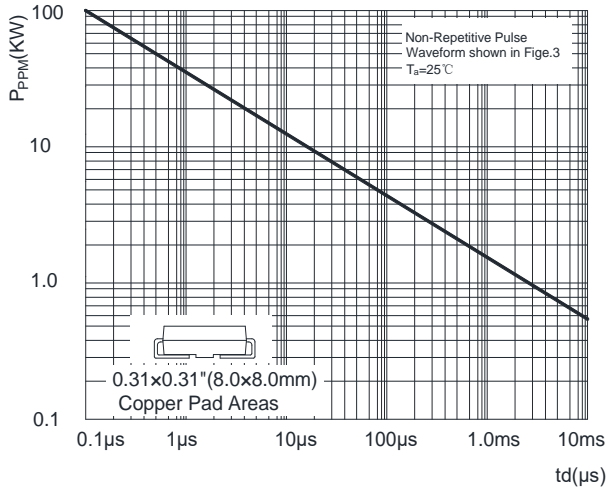

FIG2: Pulse Power or Current vs. Initial Junction Temperature

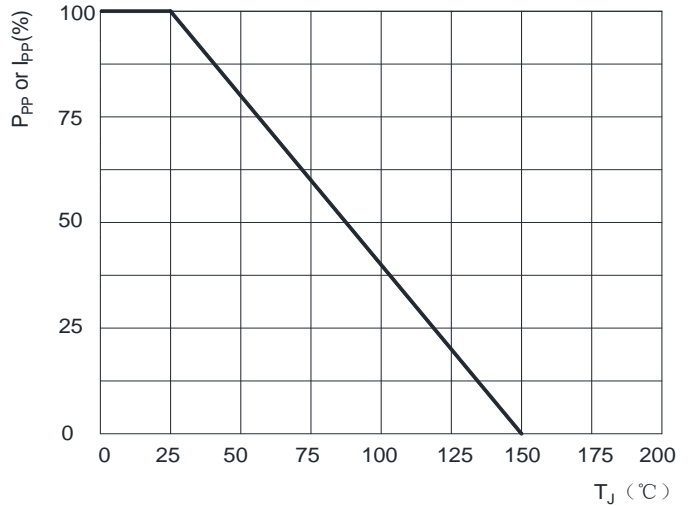

FIG3: Pulse Waveform

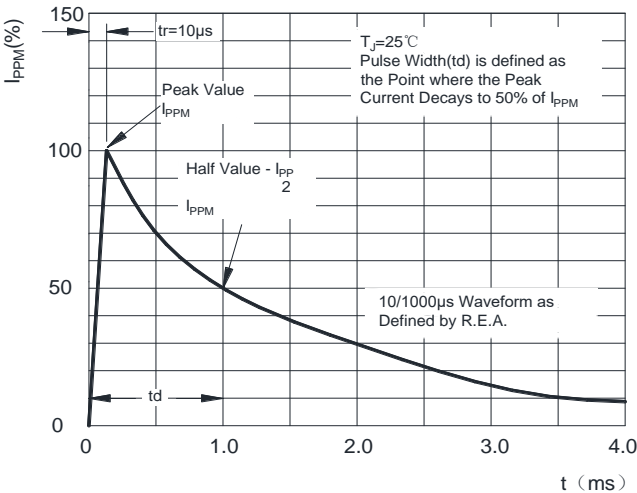

FIG4: Typical Transient Thermal Impedance

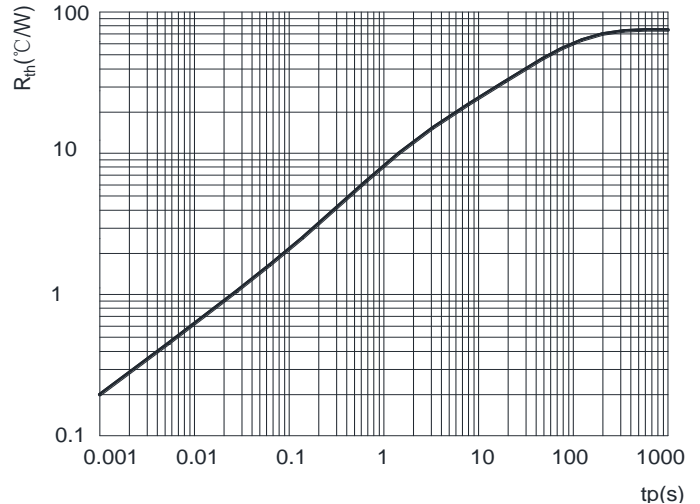

FIG5: Maximum Non-Repetitive Surge Current

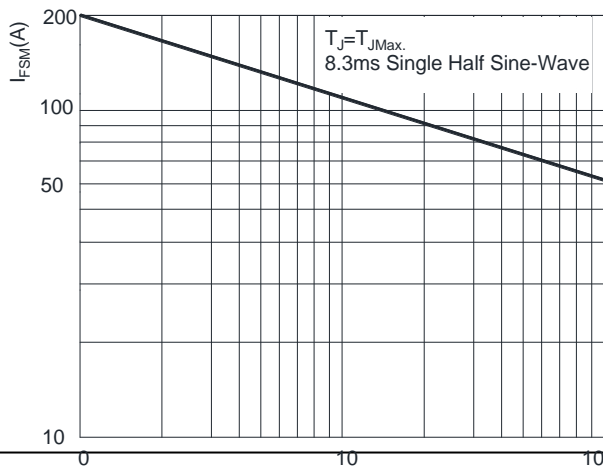
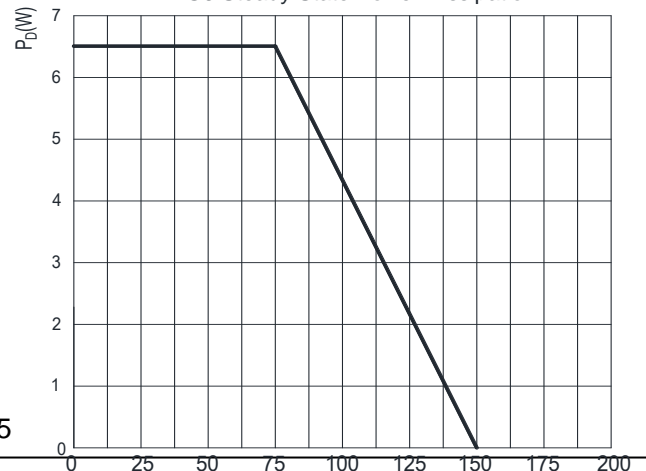

FIG6: Steady State Power Dissipation





1.5SMC12AQ THRU 1.5SMC220CAQ

■ Outline Dimensions

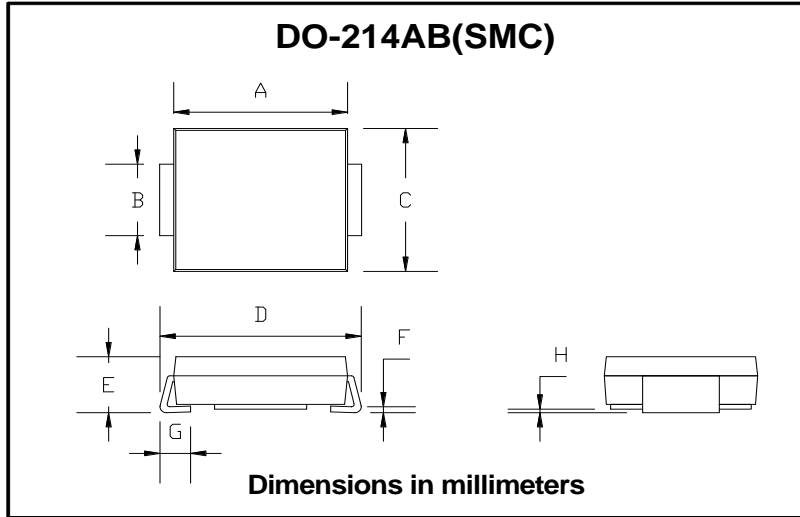

DO-214AB (SMC)		
Dim	Min	Max
A	6.60	7.11
B	2.85	3.27
C	5.59	6.22
D	7.75	8.13
E	1.99	2.61
F	0.15	0.31
G	0.76	1.52
H	0.10	0.20

■ Suggested pad layout

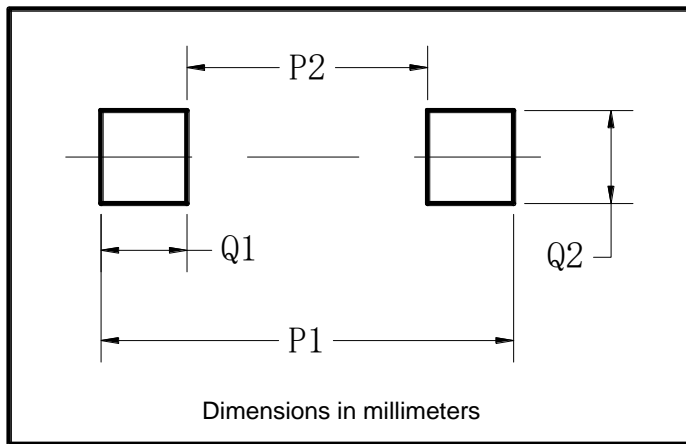

Dim	Typ
P1	9.9
P2	3.84
Q1	3.03
Q2	3.82



1.5SMC12AQ THRU 1.5SMC220CAQ

Disclaimer

The information presented in this document is for reference only. Yangzhou Yangjie Electronic Technology Co., Ltd. reserves the right to make changes without notice for the specification of the products displayed herein to improve reliability, function or design or otherwise.

The product listed herein is designed to be used with automotive electronics, are not designed for use in medical, lifesaving, lifesustaining, or military, Yangjie or anyone on its behalf, assumes no responsibility or liability for any damages resulting from such improper use of sale.

This publication supersedes & replaces all information previously supplied. For additional information, please visit our website [http:// www.21yangjie.com](http://www.21yangjie.com) , or consult your nearest Yangjie's sales office for further assistance.